

Vertical In-line Centrifugal Pump

DESMI has high quality and well established industry pumps on the market. The DESMI NSL pump is suitable for slightly contaminated thin liquids and meets the special industrial market requirements for:

- High efficiency
- Low NPSH values
- Easy installation/service
- Specific materials
- Compact design
- Standardized to modular design
- Outstanding hydraulic design performance
- Spacer-coupling options for easy maintenance
- Robust shaft design
- High efficiency impeller with low NPSH values
- Self-priming ability with a separate built-on priming pump



Capacity range:
10-1500 m ³ /h - 50-6600 US gpm at 50 Hz 10-1800 m ³ /h - 50-7900 US gpm at 60 Hz
Pressure range:
5-150 mLC - 15-500 ft at 50 Hz 5-220 mLC - 15-720 ft at 60 Hz
Temperature range:
With standard mech. shaft seal max. 80°C - 176°F With special mech. shaft seal max. 140°C - 284°F

Design Features

The pump is a vertical in-line, radially split, single-stage centrifugal pump with connecting flanges according to international standards. The pump is designed for mounting with electric motors having different international flange dimensions.

The pump casing is equipped with a replaceable sealing ring.

The impeller is made with double-curved blades to ensure low NPSH-values and high efficiency.

The bearing unit is equipped with sturdy ball bearings and the small types are fitted with lifetime-lubricated bearings. In the larger types the lower bearing is a double bearing for which a lubrication point is provided.

A shaft in stainless steel with mechanical shaft seal of an approved brand is standard.

Material specification	A	D
Pump casing	Cast iron	Bronze
Impeller	NiAl-bronze	NiAl-bronze
Wear ring	NiAl-bronze	NiAl-bronze
Shaft seal cover	Cast iron	Bronze
Shaft	Stainless	Stainless
Shaft seal	Mechanical	Mechanical

Applications

Within industrial applications the pumps are suitable for industry water circulation, cooling towers distribution, diesel transfer, district heating, district cooling etc.

All pump sizes are available as self-priming pumps with a separate built-on priming pump of the water ring type, complete with suction strainer and water feed tank.

The priming pump is equipped with its own electric motor and is suitable for manual or automatic start/stop.

The pump can also be equipped with an air-operated ejector priming unit.



mLC TOTAL HEAD: 1 m = 3,28 feet

o Max. efficiency 50 Hz

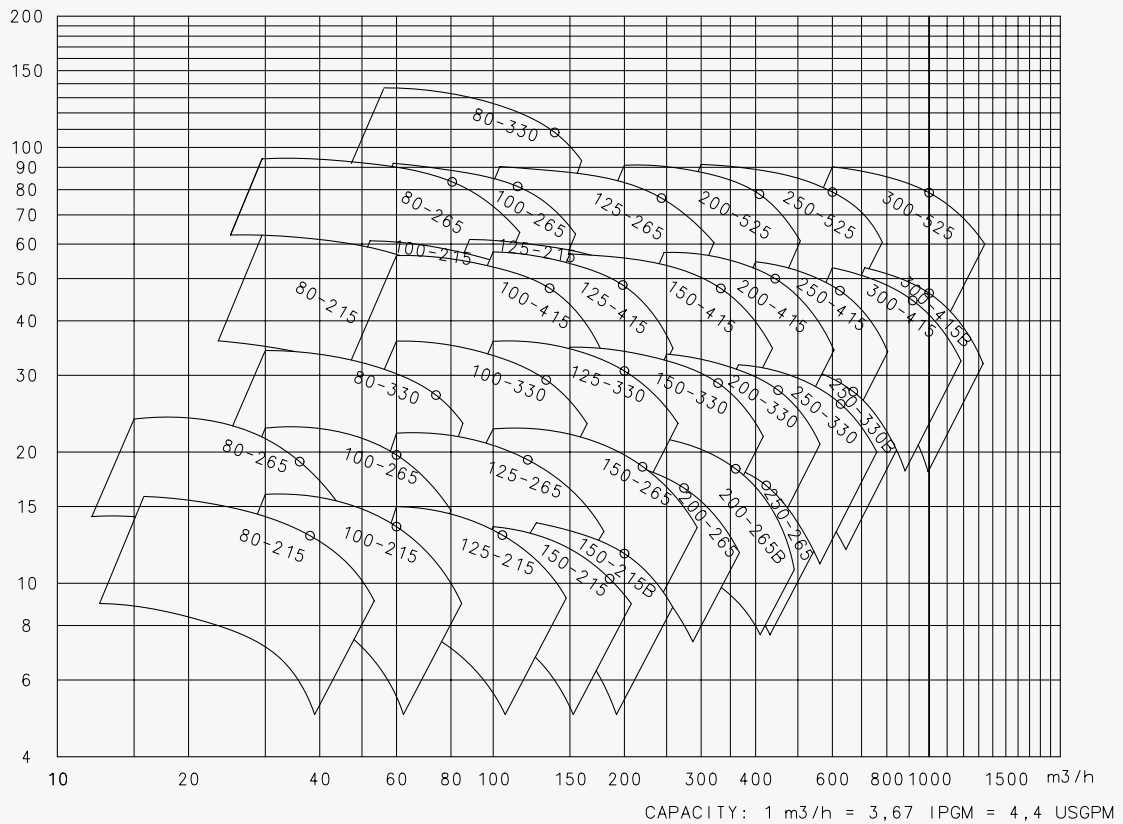

Design Details

Pumps With \varnothing 215 And \varnothing 265 Impeller
Suction and discharge flange dimensions are identical. The line through inlet and outlet is flush with the centre line of the shaft. The pumps are mounted with one impeller wear ring.

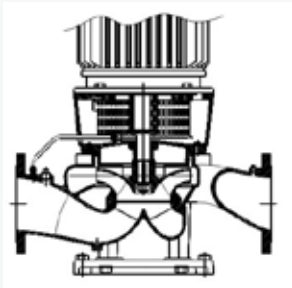

Pumps With \varnothing 330, \varnothing 415 and \varnothing 525 Impeller
Dimension of the suction flange is one size larger than that of the discharge flange. The line through inlet and outlet is tangential offset in relation to the centre line of the shaft. The pumps have two impeller wear rings.

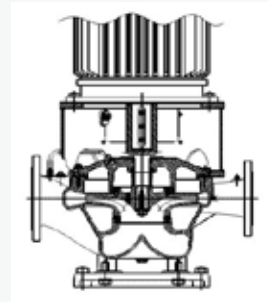

Monobloc Without Bearing

The pump is for small capacities and limited space. This version has no pump bearings, only the ball bearings in the standard electric motor. The power transmission is by rigid coupling. Dismantling of the pump parts is possible without removing the pump casing from the piping.

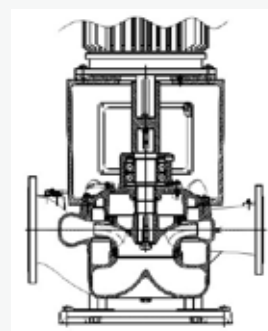
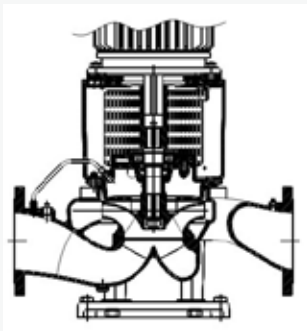

Monobloc With Bearing

The pump is for major capacities and heavy loads, especially recommended where the advantage of the spacer coupling is of no importance and where a small overall height is required.

The pump is equipped with a separate rear cover with a ball bearing and a separate motor bracket. Dismantling of the rotating pump parts is possible without removing the pump casing from the piping.

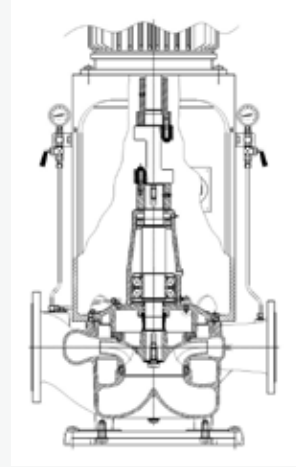
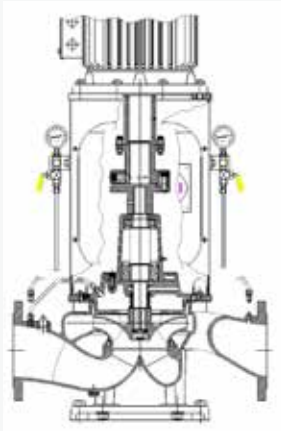

Spacer

The pump is for high capacities, heavy loads, and high pump speeds. As a special feature the pump is equipped with a spacer coupling which is a combined distance and flexible coupling. This makes it possible to remove the complete bearing housing with shaft, bearings, shaft seal, and impeller without dismantling or loosening the motor or piping. For high capacities and the resulting larger and heavier electric motors we recommend this pump version because of the easy dismantling of the rotating pump parts in connection with inspection and repair. This special feature is often a requirement within the marine industry where installations must be easy to service.